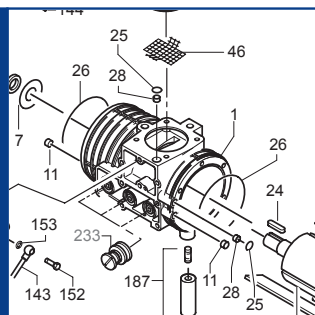

U 4.250

SERVICE

BECKER
D-42279 Wuppertal
www.becker-international.com

year XXXX
No. **D** -> **Index Variante**

type **U 4.250-XX**

frequency	XXXX	Hz
speed	XXXX	min ⁻¹
power required	XXXX	kW
inlet capacity	XXXX	m ³ /h
pressure +	XXXX	mbar
vacuum -	XXXX	mbar

Made in Germany

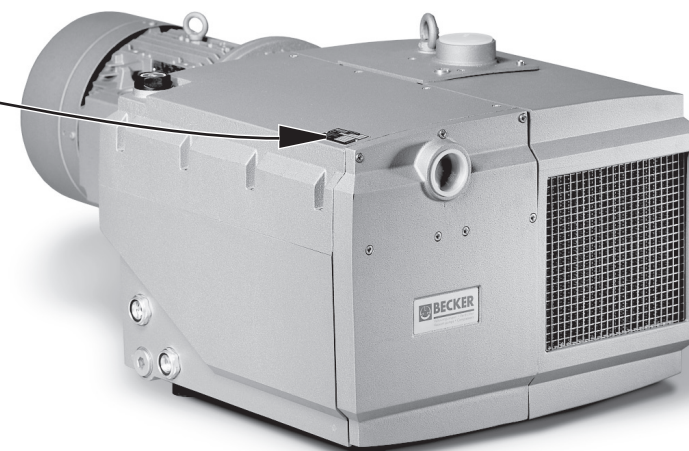

Ersatzteilliste
Spare parts list
Liste de pièces de rechange
Listino pezzi di ricambio
Lista de piezas de recambio
Lista de peças sobresselentes
Reserveonderdelenlijst
Atsarginių dalių sąrašas
Varuosad nimekirja
Rezerves daļu saraksts

Reservdeliste
Reservdelslista
Varaosuettelo
Reservdelsliste
Wykaz części zamiennych
Tartalékalkatrész lista
Seznam náhradních dílů
Seznam nadomestnih delov
Zoznam náhradných dielov
Rezervni dijelovi popis

Lista pieselor de schimb
Páirteanna spártha liosta
Κατάλογος ανταλλακτικών
Yedek parça listesi
Списък на резервните части
Перечень запасных частей
スペアパーツリスト
예비 부품 목록
备用零件目录

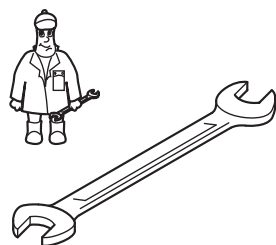

Pos.	Menge ²⁾ Quantity Quantité Quantità Cantidad	Bestell-Nr. Ident No. No. Identification No. Identificazione No. de pedido	Bezeichnung Description Designation Designazione Descripción
□	1	549000 26400	Dichtungssatz, Complete set of seals, Jeu de joints, Kit di guarnizioni, Junta Completa
5	SATZ/KIT	900507 00003	Schieber, Rotor Vane, Palette, Empujador
83	2	965412 00000	Luftentölelement, Oil separating element, Element separation huile, Cartuccia sepa-ratore olio, Elemento de desaceitar de aire

²⁾ erforderliche Bestellmenge / necessary order quantity / quantité nécessaire / quantità di ordinazione necessari / cantidad necesario

Wartung
Maintenance
Entretien
Manutenzione
Mantenimiento



SERVICE

www.becker-international.com

Sales and service network

U 4.250

Standard



Variante



U 4.250/XX

① ②

U 4.250 SAK-51 + F/K-51

③

U 4.250 SAK-54

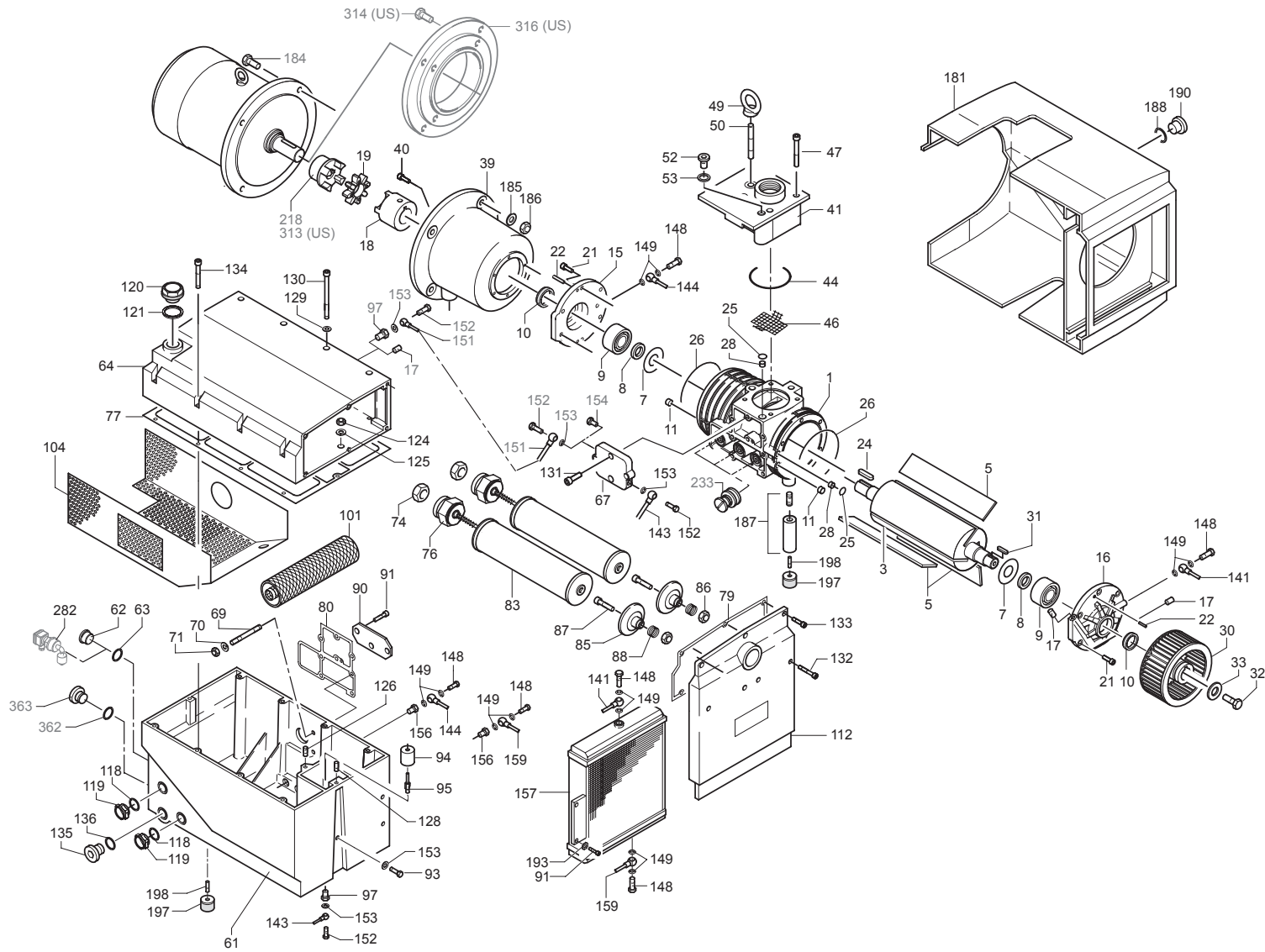

SERVICE ?

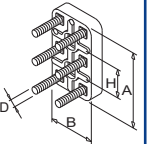
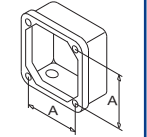
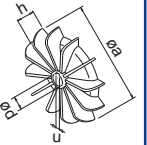
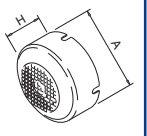
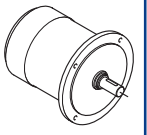



D INDEX	Pos.	Bestell Nr.	Beschreibung	DE
U 4.250	□	549000 26400	DICHTUNGSSATZ ¹⁾	
	1	000100 26500	GEHÄUSE	
	3	020000 26500	KOLBEN	
	5	900507 00003	SCHIEBER, KUNSTSTOFF (SATZ) ²⁾	
	7	917611 00000	LAGERDICHTRING	
	8	911472 00000	DISTANZSCHEIBE	
	9	906662 00000	WÄLZLAGER 6207 DIN 625	
	10	906574 00000	WELLENDICHTRING	
	11	912821 00000	VERSCHLUSSDECKEL	
	15	000800 26500	SEITENDECKEL MIT LATERNE	
	16	000700 26500	SEITENDECKEL	
	17	912871 00000	VERSCHLUSS-SCHRAUBE	
	18	902108 00000	KUPPLUNGSHÄLFTE	
	19	902210 00000	KUPPLUNGSSSCHEIBE	
	21	945331 00000	INNENSECHSKANTSCHRAUBE	
	22	948742 00000	PASSKERBSTIFT	
	24	947733 00000	PASSFEDER	
	28	952008 00000	SPANNHÜLSE	
	30	502301 26400	VENTILATOR MIT NABE	
	31	947732 00000	PASSFEDER	
	32	945270 00000	WELLENENDSCHRAUBE	
	33	949409 00000	UNTERLEGSCHNEIBE	
	39	053200 26500	LATERNE	
	40	945320 00000	INNENSECHSKANTSCHRAUBE	
	41	537501 26400	RÜCKSCHLAGVENTIL, KOMPL.	
	46	008002 26400	SIEB	
	47	945371 00000	INNENSECHSKANTSCHRAUBE	
	49	951602 00000	RINGMUTTER	
	50	946969 00000	STIFTSCHRAUBE	
	52	951228 02000	VERSCHLUSS-SCHRAUBE	
	61	002403 26400	ABSCHIEDERGEHÄUSE	
	62	951221 00000	VERSCHLUSS-SCHRAUBE	
	64	001702 26400	ÖLBEHÄLTER-DECKEL	
	67	003701 26400	DECKEL	
	69	946968 00000	STIFTSCHRAUBE	
	70	917107 00000	TELLERFEDER	
	71	947105 00000	SECHSKANTMUTTER	
	74	305800 02000	ÜBERWURFMUTTER	
	76	727500 99628	ABBLASEVENTIL	
	83	965412 00000	LUFTENTÖLELEMENT (2x) ²⁾	
	85	016801 26200	SPANNSCHEIBE	
	86	947106 00000	SECHSKANTMUTTER	
	87	945354 00000	INNENSECHSKANTSCHRAUBE	
	88	934318 00000	DRUCKFEDER	
	90	013300 26400	PRALLBLECH	
	91	945318 00000	INNENSECHSKANTSCHRAUBE	
	93	945226 00000	SECHSKANTSCHRAUBE	
	94	867800 99559	SCHWIMMER	
	95	003300 10700	DÜSE	
	97	912300 00000	ANSCHLUSS-SCHRAUBE	
	101	506000 26400	GROBABSCHIEDER, KOMPLETT	
	104	008001 26400	SIEB	
	112	003702 26400	DECKEL	
	119	907309 00000	ÖLSCHAUGLAS	
	120	916800 10000	SCHRAUBDECKEL	
	124	947104 00000	SECHSKANTMUTTER	
	125	948504 00000	FEDERRING	
	126	951001 02000	STIFTSCHRAUBE	
	128	951003 02000	STIFTSCHRAUBE	

D INDEX	Pos.	Bestell Nr.	Beschreibung	DE
	130	945383 00000	INNENSECHSKANTSCHRAUBE	
	131	945330 00000	INNENSECHSKANTSCHRAUBE	
	132	945363 00000	INNENSECHSKANTSCHRAUBE	
	133	945321 00000	INNENSECHSKANTSCHRAUBE	
	134	945324 00000	INNENSECHSKANTSCHRAUBE	
	135	951220 00000	VERSCHLUSS-SCHRAUBE	
	141	012206 26400	LEITUNG	
	143	012202 26400	ÖLRÜCKFÜHRLEITUNG	
	144	012201 26500	LEITUNG	
	148	948402 00000	HOHLSCHRAUBE	
	151	012203 26400	ÖLSAUGLEITUNG	
	152	009400 19000	KUGELSTÜCKSCHRAUBE	
	154	012900 19000	VERSCHLUSS-SCHRAUBE	
	156	912306 00000	ANSCHLUSS-SCHRAUBE	
	157	960201 26400	KÜHLER	
	159	012205 26400	LEITUNG	
	181	018301 26400	HAUBE	
	184	945127 00000	SECHSKANTSCHRAUBE	
	185	947506 00000	UNTERLEGSCHNEIBE	
	186	947106 00000	MUTTER	
	187	568100 26400	STÜTZE	
	188	949408 00000	U-SCHNEIBE	
	190	001800 20000	WELLENABSCHLUSS-SCHRAUBE	
	193	949203 00000	ZAHNSCHNEIBE	
	197	741302 00000	GUMMIPUFFER	
	198	945634 00000	GEWINDESTIFT	
	218	902100 21900	MOTORKUPPLUNG Ø38MM	
	233	537500 10700	VENTIL, KOMPL.	
	282	741103 99682	NIVEAUGEBER - OPTIONAL	
	313	902100 21300	MOTORKUPPLUNG (US)	
	314	945238 00000	SECHSKANTSCHRAUBE (US)	
	316	037900 10400	ZWISCHENFLANSCH (US)	
		960009 00200	BECKER LUBE M 100 (MINERALÖL) - 5L	
		960016 00200	BECKER LUBE S 100 (SYNTHETIKÖL) - 5L	
		960023 00200	BECKER LUBE SL 100 (LEBENSMITTELBEREICH) - 5L	

¹⁾ Dichtungssatz - 549000 26400 - Pos.: 13, 25, 26, 37, 38, 44, 53, 63, 77, 79, 80, 118, 121, 129, 136, 149, 153
²⁾ erforderliche Bestellmenge / Wartung

D INDEX	Pos.	Ident No.	Description	
U 4.250	□	549000 26400	SET OF SEALS ¹⁾	
	1	000100 26500	PUMP BODY	
	3	020000 26500	ROTOR	
	5	900507 00003	ROTOR VANE IN PLASTIC (KIT) ²⁾	
	7	917611 00000	BEARING SEALING WASHER	
	8	911472 00000	DISTANCE DISC	
	9	906662 00000	BEARING	
	10	906574 00000	SHAFT SEALING RING	
	11	912821 00000	CAP	
	15	000800 26500	LID WITH FLANGE	
	16	000700 26500	LID	
	17	912871 00000	LOCKING SCREW	
	18	902108 00000	COUPLING	
	19	902210 00000	COUPLING DISC	
	21	945331 00000	SOCKET HEAD SCREW	
	22	948742 00000	STRAIGHT PIN	
	24	947733 00000	KEY	
	28	952008 00000	LOCATING PEG	
	30	502301 26400	FAN	
	31	947732 00000	KEY	
	32	945270 00000	SHAFT END BOLD	
	33	949409 00000	WASHER	
	39	053200 26500	CONNECTION FLANGE	
	40	945320 00000	SOCKET HEAD SCREW	
	41	537501 26400	NON RETURN VALVE, ENTIRE	
	46	008002 26400	SIEVE	
	47	945371 00000	SOCKET HEAD SCREW	
	49	951602 00000	RING UNIT	
	50	946969 00000	STUD	
	52	951228 02000	LOCKING SCREW	
	61	002403 26400	HOUSING FOR OIL SEPARATION	
	62	951221 00000	LOCKING SCREW	
	64	001702 26400	OIL TANK COVER	
	67	003701 26400	COVER	
	69	946968 00000	STUD	
	70	917107 00000	SPRING COLLAR	
	71	947105 00000	HEX.NUT	
	74	305800 02000	COUPLING NUT	
	76	727500 99628	BLOW OFF VALVE	
	83	965412 00000	OIL SEPARATION ELEMENT (2x) ²⁾	
	85	016801 26200	CLAMPING DISC	
	86	947106 00000	HEX.NUT	
	87	945354 00000	SOCKET HEAD SCREW	
	88	934318 00000	PRESSURE SPRING	
	90	013300 26400	METAL FILTER	
	91	945318 00000	SOCKET HEAD SCREW	
	93	945226 00000	HEX. HEAD SCREW	
	94	867800 99559	FLOAT	
	95	003300 10700	NOZZLE	
	97	912300 00000	CONNECTING SCREW	
	101	506000 26400	COARSE SEPARATOR	
	104	008001 26400	SIEVE	
	112	003702 26400	COVER	
	119	907309 00000	OIL SIGHT GLASS	
	120	916800 10000	COVER	
	124	947104 00000	HEX.NUT	
	125	948504 00000	SPRING WASHER	
	126	951001 02000	STUD	
	128	951003 02000	STUD	

D INDEX	Pos.	Ident No.	Description	
	130	945383 00000	SOCKET HEAD SCREW	
	131	945330 00000	SOCKET HEAD SCREW	
	132	945363 00000	SOCKET HEAD SCREW	
	133	945321 00000	SOCKET HEAD SCREW	
	134	945324 00000	SOCKET HEAD SCREW	
	135	951220 00000	LOCKING SCREW	
	141	012206 26400	PIPE	
	143	012202 26400	OIL RETURN PIPE	
	144	012201 26500	PIPE	
	148	948402 00000	HOLLOW SCREW	
	151	012203 26400	OIL SUCTION PIPE	
	152	009400 19000	HOLLOW HOLDING SCREW	
	154	012900 19000	LOCKING SCREW	
	156	912306 00000	CONNECTING SCREW	
	157	960201 26400	COOLER	
	159	012205 26400	PIPE	
	181	018301 26400	PROTECTING HOOD	
	184	945127 00000	HEX-HEAD SCREW	
	185	947506 00000	WASHER	
	186	947106 00000	NUT	
	187	568100 26400	SUPPORT PILLAR	
	188	949408 00000	WASHER	
	190	001800 20000	SCREW	
	193	949203 00000	TOOTHED SPRING WASHER	
	197	741302 00000	RUBBER BUFFER	
	198	945634 00000	THREADED PIN	
	218	902100 21900	COUPLING MOTOR SIDE Ø38MM	
	233	537500 10700	VALVE, ENTIRE	
	282	741103 99682	OIL LEVEL CONTROL - OPTIONAL	
	313	902100 21300	COUPLING MOTOR SIDE (US)	
	314	945238 00000	HEX-HEAD SCREW (US)	
	316	037900 10400	INTERMEDIATE FLANGE (US)	
		960009 00200	BECKER LUBE M 100 (MINERAL OIL) - 5L	
		960016 00200	BECKER LUBE S 100 (SYNTHETIC OIL) - 5L	
		960023 00200	BECKER LUBE SL 100 (FOOD SECTOR) - 5L	

¹⁾ Set of seals - 549000 26400 - Pos.: 13, 25, 26, 37, 38, 44, 53, 63, 77, 79, 80, 118, 121, 129, 136, 149, 153

²⁾ necessary order quantity / maintenance

D INDICE	Pos.	No. Identification	Designation	FR	
U 4.250	□	549000 26400	JEU DE JOINTS ¹⁾		
	1	000100 26500	CORP DE POMPE		
	3	020000 26500	PISTON		
	5	900507 00003	PALETTE ON PLASTIQUE (KIT) ²⁾		
	7	917611 00000	RONDELLE D'ETANCHEITE DU ROULEMENT		
	8	911472 00000	DISQUE AJUSTAGE		
	9	906662 00000	ROULEMENT		
	10	906574 00000	BAGUE D'ETANCHEITE P.L'AXE		
	11	912821 00000	COUVERCLE		
	15	000800 26500	COUVERCLE AVEC BRIDE		
	16	000700 26500	COUVERCLE		
	17	912871 00000	BOUCHON		
18	902108 00000	ACCOUPEMENT			
19	902210 00000	DISQUE D'ACCOUPEMENT			
21	945331 00000	VIS HEXAGONALE INTERNE			
22	948742 00000	GOUPILLE CYLINDRIQUE			
24	947733 00000	CLAVETTE			
28	952008 00000	DOVILLE DE ETRAGE			
30	502301 26400	VENTILATEUR			
31	947732 00000	CLAVETTE			
32	945270 00000	VIS BOUT D'ARBRE			
33	949409 00000	RONDELLE			
39	053200 26500	BRIDE DE RACCORDEMENT			
40	945320 00000	VIS HEXAGONALE INTERNE			
41	537501 26400	SOUPAPE ANTI-RETOUR, ENTIER			
46	008002 26400	FILTRE			
47	945371 00000	VIS HEXAGONALE INTERNE			
49	951602 00000	ECROU A ANNEAU			
50	946969 00000	PRISONNIER			
52	951228 02000	BOUCHON			
61	002403 26400	CORP DE SEPARATEUR D'HUILE			
62	951221 00000	BOUCHON			
64	001702 26400	COUVERCLE RESERVOIR D'HUILE			
67	003701 26400	COUVERCLE			
69	946968 00000	PRISONNIER			
70	917107 00000	RONDELLE À RESSORT			
71	947105 00000	ECROU A 6 PANS			
74	305800 02000	ECROU			
76	727500 99628	SILENCIEUX			
83	965412 00000	ELEMENT SEPARATION HUILE (2x) ²⁾			
85	016801 26200	DISQUE DE SERRAGE			
86	947106 00000	ECROU A 6PANS			
87	945354 00000	VIS HEXAGONALE INTERNE			
88	934318 00000	MOLLA DELLA PRESSIONE			
90	013300 26400	FILTRE METALIQUE			
91	945318 00000	VIS HEXAGONALE INTERNE			
93	945226 00000	VIS HEXAGONALE			
94	867800 99559	PIED CAOUTCHOVE			
95	003300 10700	GICLEUR			
97	912300 00000	VIS DE RACCORD			
101	506000 26400	SEPARATEUR A GROS			
104	008001 26400	FILTRE			
112	003702 26400	COUVERCLE			
119	907309 00000	VERRE REGARD			
120	916800 10000	COUVERCLE			
124	947104 00000	ECROU A 6PANS			
125	948504 00000	ANNEAU-RESSORT			
126	951001 02000	PRISONNIER			
128	951003 02000	PRISONNIER			

D INDICE	Pos.	No. Identification	Designation	FR	
	130	945383 00000	VIS HEXAGONALE INTERNE		
	131	945330 00000	VIS HEXAGONALE INTERNE		
	132	945363 00000	VIS HEXAGONALE INTERNE		
	133	945321 00000	VIS HEXAGONALE INTERNE		
	134	945324 00000	VIS HEXAGONALE INTERNE		
	135	951220 00000	BOUCHON		
	141	012206 26400	TUYAU		
	143	012202 26400	TUYAU D'HUILE		
	144	012201 26500	TUYAU		
	148	948402 00000	VIS CREUSE		
	151	012203 26400	TUYAU D'HUILE		
	152	009400 19000	VIS CREUSE DE FIXATION		
	154	012900 19000	BUCHON		
	156	912306 00000	VIS DE RACCORD		
	157	960201 26400	REFROIDISSEUR		
	159	012205 26400	TUYAU		
	181	018301 26400	CARTER PROTECTEUR		
	184	945127 00000	VIS HEXAGONALE		
	185	947506 00000	RONDELLE		
	186	947106 00000	ECROU		
	187	568100 26400	SUPPORT INTERMEDIAIRE		
	188	949408 00000	RONDELLE		
	190	001800 20000	VIS		
	193	949203 00000	DENT DISQUE		
	197	741302 00000	AMORTISSEUR EN CAOUTCHOUC		
	198	945634 00000	GOUPILLE FILETEE		
	218	902100 21900	ACCOUPEMENT MOTEUR Ø38MM		
	233	537500 10700	SOUPAPE, ENTIER		
	282	741103 99682	INDICATEUR DE NIVEAU - EN OPTION		
	313	902100 21300	ACCOUPEMENT MOTEUR (US)		
	314	945238 00000	VIS HEXAGONALE (US)		
	316	037900 10400	BRIDE INTERMEDIAIRE (US)		
		960009 00200	BECKER LUBE M 100 (HUILE MINÉRALE) - 5L		
		960016 00200	BECKER LUBE S 100 (L'HUILE SYNTHÉTIQUE) - 5L		
		960023 00200	BECKER LUBE SL 100 (SECTEUR DE L'ALIMENTATION) - 5L		

¹⁾ Jeu de joints - 549000 26400 - Pos.: 13, 25, 26, 37, 38, 44, 53, 63, 77, 79, 80, 118, 121, 129, 136, 149, 153
²⁾ quantité nécessaire / entretien

D INDICE	Pos.	No. Identificazione	Designazione	IT	
U 4.250	□	549000 26400	SERIE DI GUARNIZIONE ¹⁾		
	1	000100 26500	CARASSA		
	3	020000 26500	ROTORE		
	5	900507 00003	PALETTE IN PLASTICA (KIT) ²⁾		
	7	917611 00000	ANELLO DI TENUTA DEL CUSCINETTO		
	8	911472 00000	DISCO DISTANZA		
	9	906662 00000	CUSCINETTO		
	10	906574 00000	GUARNIZIONE PER L'ALBERO		
	11	912821 00000	COPERCHIO		
	15	000800 26500	COPERCHIO CON FLANGIA		
	16	000700 26500	COPERCHIO		
	17	912871 00000	VITE DI CHIUSURA		
	18	902108 00000	GIUNTO		
	19	902210 00000	DISCO GIUNTO		
	21	945331 00000	VITE ESAGONALE INTERNA		
	22	948742 00000	PERNO		
	24	947733 00000	CHIAVETTA		
	28	952008 00000	SPINE DI RISCONTRO		
	30	502301 26400	VENTILATORE		
	31	947732 00000	CHIAVETTA		
	32	945270 00000	VITE DI CHIUSURA ALBERO		
	33	949409 00000	RONDELLA		
	39	053200 26500	FLANGIA DI RACCORDE		
	40	945320 00000	VITE ESAGONALE INTERNA		
	41	537501 26400	VALVOLA NON RITORNO, INTERO		
	46	008002 26400	FILTRO		
	47	945371 00000	VITE ESAGONALE INTERNA		
	49	951602 00000	GOLFARE CON FORO FILETTATO		
	50	946969 00000	L'ASTA A VITE		
	52	951228 02000	VITE DI CHIUSURA		
	61	002403 26400	CARASSA SEPARATORE OLIO		
	62	951221 00000	VITE DI CHIUSURA		
	64	001702 26400	COPERCHIO SERBATOIO OLIO		
	67	003701 26400	COPERCHIO		
	69	946968 00000	L'ASTA A VITE		
	70	917107 00000	RONDELLA A MOLLA		
	71	947105 00000	DADO ESAGONALE		
	74	305800 02000	DADO DI RISVOLTO		
	76	727500 99628	SILENZIATORE		
	83	965412 00000	CARTUCCIA SEPARATORE OLIO (2x) ²⁾		
	85	016801 26200	DISCO DI FISSAGGIO		
	86	947106 00000	DADO ESAGONALE		
	87	945354 00000	VITE ESAGONALE INTERNA		
	88	934318 00000	MOLLA DELLA PRESSIONE		
	90	013300 26400	FILTRO METALICO		
	91	945318 00000	VITE ESAGONALE INTERNA		
	93	945226 00000	VITE ESAGONALE		
	94	867800 99559	GALLEGGIANTE		
	95	003300 10700	UGELLO		
	97	912300 00000	ATTACO FILETTATO		
	101	506000 26400	SEPARATORE GROSSOLANO		
	104	008001 26400	FILTRO		
	112	003702 26400	COPERCHIO		
	119	907309 00000	SPIA LIVELLO OLIO		
	120	916800 10000	COPERCHIO		
	124	947104 00000	DADO ESAGONALE		
	125	948504 00000	ANELLO A MOLLA		
	126	951001 02000	L'ASTA A VITE		
	128	951003 02000	L'ASTA A VITE		







D INDICE	Pos.	No. Identificazione	Designazione	IT	
	130	945383 00000	VITE ESAGONALE INTERNA		
	131	945330 00000	VITE ESAGONALE INTERNA		
	132	945363 00000	VITE ESAGONALE INTERNA		
	133	945321 00000	VITE ESAGONALE INTERNA		
	134	945324 00000	VITE ESAGONALE INTERNA		
	135	951220 00000	VITE DI CHIUSURA		
	141	012206 26400	CONDOTTO		
	143	012202 26400	CONDOTTO OLIO		
	144	012201 26500	CONDOTTO		
	148	948402 00000	VITE ESAGONALE		
	151	012203 26400	CONDOTTO OLIO		
	152	009400 19000	VITE PASSAGGIO OLIO		
	154	012900 19000	VITE DI CHIUSURA		
	156	912306 00000	ATTACO FILETTATO		
	157	960201 26400	RAFFREDDATORE		
	159	012205 26400	CONDOTTO		
	181	018301 26400	CARTER DI PROTEZIONE		
	184	945127 00000	VITE ESAGONALE		
	185	947506 00000	RONDELLA		
	186	947106 00000	DADO		
	187	568100 26400	SUPPORTO		
	188	949408 00000	RONDELLA		
	190	001800 20000	VITE		
	193	949203 00000	DISCO A DENTE		
	197	741302 00000	AMMORTIZZATORE IN GOMMA		
	198	945634 00000	SPINA FILETTATURA		
	218	902100 21900	GIUNTO MOTORE Ø38MM		
	233	537500 10700	VALVOLA, INTERO		
	282	741103 99682	SONDA D'OLIO - OPTIONALE		
	313	902100 21300	GIUNTO MOTORE (US)		
	314	945238 00000	VITE ESAGONALE (US)		
	316	037900 10400	FLANGE INTERMEDIA (US)		
		960009 00200	BECKER LUBE M 100 (OLIO MINERALE) - 5L		
		960016 00200	BECKER LUBE S 100 (OLIO SINTETICO) - 5L		
		960023 00200	BECKER LUBE SL 100 (SETTORE ALIMENTARE) - 5L		

¹⁾ Serie di guarnizione - 549000 26400 - Pos.: 13, 25, 26, 37, 38, 44, 53, 63, 77, 79, 80, 118, 121, 129, 136, 149, 153
²⁾ quantità di ordinazione necessari / manutenzione

D INDICE	Pos.	No. De pedido	Descripción	ES	
				ES	
U 4.250	■	549000 26400	JUNTA COMPLETA ¹⁾		
	1	000100 26500	CARCASA		
	3	020000 26500	ÉMBOLO		
	5	900507 00003	EMPUJADOR DE PLÁSTICO (KIT) ²⁾		
	7	917611 00000	ANILLO DE COJINETE DE JUNTA		
	8	911472 00000	ARANDELA DISTANCIADORA		
	9	906662 00000	COJINETE DE RODAMIENTO		
	10	906574 00000	ANILLO DE JUNTA DE ÁRBOL		
	11	912821 00000	TAPA DE CIERRE		
	15	000800 26500	TAPA LATERAL CONFAROL		
	16	000700 26500	TAPA LATERAL		
	17	912871 00000	TORNILLO DE CIERRE		
	18	902108 00000	MITAD DE ACOPLAMIENTO		
	19	902210 00000	DISCO DE ACOPLAMIENTO		
	21	945331 00000	TORNILLO HEXAGONAL INTERIOR		
	22	948742 00000	PASADOR ENTALLADO DE AJUSTE		
	24	947733 00000	LENGÜETA DE AJUSTE		
	28	952008 00000	CASQUILLO TENSOR		
	30	502301 26400	VENTILADOR CON CUBO		
	31	947732 00000	LENGÜETA DE AJUSTE		
	32	945270 00000	TORNILLO TERMINAL DE ÁRBOL		
	33	949409 00000	ARANDELA		
	39	053200 26500	FAROL		
	40	945320 00000	TORNILLO HEXAGONAL INTERIOR		
	41	537501 26400	VÁLVULA ANTIRRETORNO COMPLETA		
	46	008002 26400	CRIBA		
	47	945371 00000	TORNILLO HEXAGONAL INTERIOR		
	49	951602 00000	TUERCA DE CÁNCAMO		
	50	946969 00000	ESPÁRRAGO		
	52	951228 02000	TORNILLO DE CIERRE		
	61	002403 26400	CARCASA SEPARADORA		
	62	951221 00000	TORNILLO DE CIERRE		
	64	001702 26400	TAPA DE RECIPIENTE DE ACEITE		
	67	003701 26400	TAPA		
	69	946968 00000	ESPÁRRAGO		
	70	917107 00000	ARANDELA DE APOYO DEL RESORTE		
	71	947105 00000	TUERCA HEXAGONAL		
	74	305800 02000	SOBRETUERCA		
	76	727500 99628	VÁLVULA DE BARRIDO		
	83	965412 00000	ELEMENTO DE DESACEITAR DE AIRE (2x) ²⁾		
	85	016801 26200	ARANDELA ELÁSTICA		
	86	947106 00000	TUERCA HEXAGONAL		
	87	945354 00000	TORNILLO HEXAGONAL INTERIOR		
	88	934318 00000	MUELLE DE COMPRESIÓN		
	90	013300 26400	CHAPA DE REBOTE		
	91	945318 00000	TORNILLO HEXAGONAL INTERIOR		
	93	945226 00000	TORNILLO DE CABEZA HEXAGONAL		
	94	867800 99559	FLOTADOR		
	95	003300 10700	TOBERA		
	97	912300 00000	TORNILLO DE EMPALME		
	101	506000 26400	SEPARADOR DE SÓLIDOS GRUESOS COMPLETO		
	104	008001 26400	CRIBA		
	112	003702 26400	TAPA		
	119	907309 00000	CRISTAL MIRILLA DE ACEITE		
	120	916800 10000	TAPA ROSCADA		
	124	947104 00000	TUERCA HEXAGONAL		
	125	948504 00000	ARANDELA DE MUELLE		
	126	951001 02000	ESPÁRRAGO		
	128	951003 02000	ESPÁRRAGO		

D INDICE	Pos.	No. De pedido	Descripción	ES	
				ES	
	130	945383 00000	TORNILLO HEXAGONAL INTERIOR		
	131	945330 00000	TORNILLO HEXAGONAL INTERIOR		
	132	945363 00000	TORNILLO HEXAGONAL INTERIOR		
	133	945321 00000	TORNILLO HEXAGONAL INTERIOR		
	134	945324 00000	TORNILLO HEXAGONAL INTERIOR		
	135	951220 00000	TORNILLO DE CIERRE		
	141	012206 26400	CONDUCTO		
	143	012202 26400	CONDUCTO DE RETROALIMENTACIÓN DE ACEITE		
	144	012201 26500	CONDUCTO		
	148	948402 00000	TORNILLO HUECO		
	151	012203 26400	CONDUCTO DE ASPIRACIÓN DE ACEITE		
	152	009400 19000	TORNILLO DE PIEZA ESFÉRICA		
	154	012900 19000	TORNILLO DE CIERRE		
	156	912306 00000	TORNILLO DE EMPALME		
	157	960201 26400	REFRIGERADOR		
	159	012205 26400	CONDUCTO		
	181	018301 26400	SOMBRERETE		
	184	945127 00000	TORNILLO DE CABEZA HEXAGONAL		
	185	947506 00000	ARANDELA		
	186	947106 00000	TUERCA		
	187	568100 26400	APOYO		
	188	949408 00000	ARANDELA		
	190	001800 20000	TORNILLO TERMINAL DE ÁRBOL		
	193	949203 00000	POLEA DENTADA		
	197	741302 00000	AMORTIGUADOR DE GOMA		
	198	945634 00000	VARILLA ROSCADA		
	218	902100 21900	ACOPLAMIENTO DE MOTOR Ø38MM		
	233	537500 10700	VÁLVULA COMPLETA		
	282	741103 99682	GENERADOR DE NIVEL - OPCIONAL		
	313	902100 21300	ACOPLAMIENTO DE MOTOR (US)		
	314	945238 00000	TORNILLO DE CABEZA HEXAGONAL (US)		
	316	037900 10400	BRIDA INTERMEDIA (US)		
		 960009 00200	BECKER LUBE M 100 (ACEITE MINERAL) - 5L		
		960016 00200	BECKER LUBE S 100 (ACEITE SINTÉTICO) - 5L		
		960023 00200	BECKER LUBE SL 100 (SECTOR ALIMENTARIO) - 5L		

¹⁾ Junta completa - 549000 26400 - Pos.: 13, 25, 26, 37, 38, 44, 53, 63, 77, 79, 80, 118, 121, 129, 136, 149, 153
²⁾ cantidad necesario / mantenimiento

U 4.250	Variante 	Pos. ²⁾	Bestell Nr. / Ident No. / No. Identification / No. Identificazione / No. De pedido		Beschreibung / Description / Designation / Designazione / Desripcion	
			  	  		
① U 4.250 SA/K-51 ② U 4.250 F/K-51 - mit Ölbadheizung, Niveau-Geber und Thermostat - with oil bath heating, level transmitter and heat valve - avec chauffage du bain d'huile, capteur de niveau et thermostat - con riscaldamento a bagno d'olio, indicatore di livello e termostato - con calefacción de baño de aceite, codificador de nivel y termostato		61		002403-26400	ÖLABSCHEIDERGEHÄUSE / HOUSING FOR OIL SEPARATION / CARCASSE POUR SEPARATION D'HUILLE / CARCASSA SEPARATORE OLIO / CARCASA SEPARADORA DE ACEITE	
		62		951221-00000	VERSCHLUSSSCHRAUBE / LOCKING SCREW / BOUCHON / VITE DI CHIUSURA / TORNILLO DE CIERRE	
		282	741103 99682			NIVEAUGEBER / LEVEL TRANSMITTER / CAPTEUR DE NIVEAU / INDICATORE DI LIVELLO / CODIFICADOR DE NIVEL
		340	002404 26400			ÖLABSCHEIDERGEHÄUSE / HOUSING FOR OIL SEPARATION / CARCASSE POUR SEPARATION D'HUILLE / CARCASSA SEPARATORE OLIO / CARCASA SEPARADORA DE ACEITE
		341	960202 26400			ROHRHEIZKÖRPER / PIPE HEATER / CORPS DE CHAUFFE / SCALDIGLIA / CALEFACTOR TUBULAR
		342	943400 70000			TEMPERATUR-WÄCHTER / THERMOSTAT / THERMOSTAT / INTERRUPTORE TERMICO / TERMOSTATO
③ U 4.250 SA/K-54 - mit zusätzlicher Ölablassbohrung - with additional oil draining bore hole - avec trou de vidange d'huile - con foro di scarico dell'olio aggiuntivo - con perforación de salida de aceite adicional		61		002403-26400	ÖLABSCHEIDERGEHÄUSE / HOUSING FOR OIL SEPARATION / CARCASSE POUR SEPARATION D'HUILLE / CARCASSA SEPARATORE OLIO / CARCASA SEPARADORA DE ACEITE	
		361	002405 26400			ÖLABSCHEIDERGEHÄUSE / HOUSING FOR OIL SEPARATION / CARCASSE POUR SEPARATION D'HUILLE / CARCASSA SEPARATORE OLIO / CARCASA SEPARADORA DE ACEITE
		363	951220 00100			VERSCHLUSSSCHRAUBE / LOCKING SCREW / BOUCHON / VITE DI CHIUSURA / TORNILLO DE CIERRE

²⁾ variantenabhängige Bauteile / variant-dependent components / composants variante-dependantes / componenti variante-dispendenti / componentes variante-dependientes